

# LiftMaster®

## USER'S GUIDE

FOR RESIDENTIAL USE ONLY

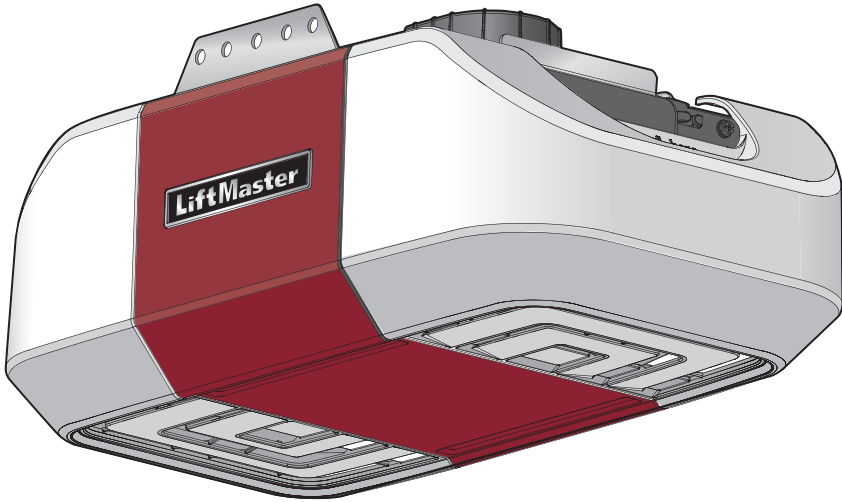

# Wi-Fi Garage Door Opener

## MODELS 8550W • 8557W • 8587W

- Please read this guide and the enclosed safety materials carefully!
- The door **WILL NOT CLOSE** unless the Protector System® is connected and properly aligned.
- Periodic checks of the garage door opener are required to ensure safe operation.
- This garage door opener is **ONLY** compatible with MyQ® and Security+ 2.0™ accessories.
- **DO NOT** enable the Timer-to-Close feature if you are installing the garage door opener on a one-piece door. The Timer-to-Close is to be used **ONLY** with sectional doors.
- Attach enclosed warning labels to the location indicated on label.



SERIAL NUMBER: \_\_\_\_\_

Please write the MyQ Serial number in the box above. See page 2.

Register online at:  
[www.prodregister.com/LiftMaster](http://www.prodregister.com/LiftMaster)



# Contents

Important Safety Instructions .....	3-4
Programming .....	5-7
Connect your Garage Door Opener to Your Smart Phone .....	5-6
Remote Control .....	7
Erase the Memory .....	7
Operation .....	8-10
To Open the Door Manually .....	8
Battery Backup .....	9
The Door Control .....	9
The Protector System® (Safety Reversing Sensors) .....	10
Adjustment .....	11-13
Introduction .....	11
Program the Travel .....	12
Test the Safety Reversal System .....	13
Test the Protector System® .....	13
Maintenance .....	14
Troubleshooting .....	14
Repair Parts .....	15
Warranty .....	16

## Safety Symbol and Signal Word Review

This garage door opener has been designed and tested to offer safe service provided it is installed, operated, maintained and tested in strict accordance with the instructions and warnings contained in this manual.

When you see these Safety Symbols and Signal Words on the following pages, they will alert you to the possibility of **serious injury or death** if you do not comply with the warnings that accompany them. The hazard may come from something mechanical or from electric shock. Read the warnings carefully.

**⚠ WARNING**

**Mechanical**

**⚠ WARNING**

**Electrical**

When you see this Signal Word on the following pages, it will alert you to the possibility of damage to your garage door and/or the garage door opener if you do not comply with the cautionary statements that accompany it. Read them carefully.

**CAUTION**

## myQ® Serial Number:

Write down the following information for future reference:

MyQ® Serial Number:

Accessory Setup Code:

Product S/N:

Date of Purchase:

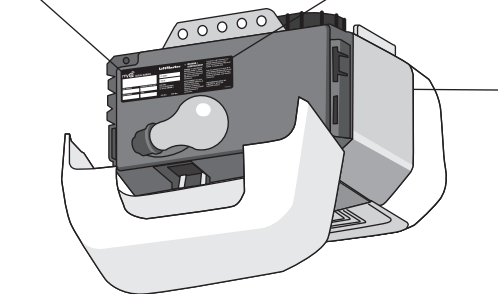

Product Serial Number

## Unattended Operation

The Timer-to-Close (TTC) feature, the MyQ® Smartphone Control app, and MyQ® Garage Door and Gate Monitor are examples of unattended close and are to be used **ONLY** with sectional doors. Any device or feature that allows the door to close without being in the line of sight of the door is considered unattended close. The Timer-to-Close (TTC) feature, the MyQ® Smartphone Control, and any other MyQ® devices are to be used **ONLY** with sectional doors.

## IMPORTANT INSTALLATION INSTRUCTIONS

### **WARNING**

### To reduce the risk of SEVERE INJURY or DEATH:

1. READ AND FOLLOW ALL WARNINGS AND INSTRUCTIONS.
2. Install garage door opener ONLY on properly balanced and lubricated garage door. An improperly balanced door may NOT reverse when required and could result in SEVERE INJURY or DEATH.
3. ALL repairs to cables, spring assemblies and other hardware MUST be made by a trained door systems technician BEFORE installing opener.
4. Disable ALL locks and remove ALL ropes connected to garage door BEFORE installing opener to avoid entanglement.
5. Install garage door opener 7 feet (2.13 m) or more above floor.
6. Mount the emergency release within reach, but at least 6 feet (1.83 m) above the floor and avoiding contact with vehicles to avoid accidental release.
7. NEVER connect garage door opener to power source until instructed to do so.
8. NEVER wear watches, rings or loose clothing while installing or servicing opener. They could be caught in garage door or opener mechanisms.
9. Install wall-mounted garage door control:
  - within sight of the garage door.
  - out of reach of children at minimum height of 5 feet (1.5 m).
  - away from ALL moving parts of the door.
10. Place entrapment warning label on wall next to garage door control.
11. Place manual release/safety reverse test label in plain view on inside of garage door.
12. Upon completion of installation, test safety reversal system. Door MUST reverse on contact with a 1-1/2" (3.8 cm) high object (or a 2x4 laid flat) on the floor.
13. To avoid SERIOUS PERSONAL INJURY or DEATH from electrocution, disconnect ALL electric and battery power BEFORE performing ANY service or maintenance.
14. DO NOT install on a one-piece door if using devices or features providing unattended close. Unattended devices and features are to be used ONLY with sectional doors.
15. **SAVE THESE INSTRUCTIONS.**

## IMPORTANT SAFETY INSTRUCTIONS

### **WARNING**

### To reduce the risk of SEVERE INJURY or DEATH:

1. READ AND FOLLOW ALL WARNINGS AND INSTRUCTIONS.
2. ALWAYS keep remote controls out of reach of children. NEVER permit children to operate or play with garage door control push buttons or remote controls.
3. ONLY activate garage door when it can be seen clearly, it is properly adjusted, and there are no obstructions to door travel.
4. ALWAYS keep garage door in sight and away from people and objects until completely closed. NO ONE SHOULD CROSS THE PATH OF THE MOVING DOOR.
5. NO ONE SHOULD GO UNDER A STOPPED, PARTIALLY OPENED DOOR.
6. If possible, use emergency release handle to disengage trolley ONLY when garage door is CLOSED. Use caution when using this release with the door open. Weak or broken springs or unbalanced door could result in an open door falling rapidly and/or unexpectedly and increasing the risk of SEVERE INJURY or DEATH.
7. NEVER use emergency release handle unless garage doorway is clear of persons and obstructions.
8. NEVER use emergency release handle to pull garage door open or closed. If rope knot becomes untied, you could fall.
9. After ANY adjustments are made, the safety reversal system MUST be tested.
10. Safety reversal system MUST be tested every month. Garage door MUST reverse on contact with 1-1/2" high (3.8 cm) object (or a 2x4 laid flat) on the floor. Failure to adjust the garage door opener properly increases the risk of SEVERE INJURY or DEATH.
11. ALWAYS KEEP GARAGE DOOR PROPERLY BALANCED. An improperly balanced door may NOT reverse when required and could result in SEVERE INJURY or DEATH.
12. ALL repairs to cables, spring assemblies and other hardware, ALL of which are under EXTREME tension, MUST be made by a trained door systems technician.
13. ALWAYS disconnect electric power to garage door opener BEFORE making ANY repairs or removing covers.
14. This operator system is equipped with an unattended operation feature. The door could move unexpectedly. NO ONE SHOULD CROSS THE PATH OF THE MOVING DOOR.
15. DO NOT install on a one-piece door if using devices or features providing unattended close. Unattended devices and features are to be used ONLY with sectional doors.
16. **SAVE THESE INSTRUCTIONS.**

# Connect With Your Smartphone

## Before You Begin

You will need:

- Wi-Fi enabled smartphone, tablet or laptop
- Broadband Internet Connection
- Wi-Fi® signal in the garage
- Password for your home network
- MyQ Serial number (Provided during step 3 and located on the garage door opener.)

## Test the Wi-Fi® Signal Strength

Make sure your mobile device is connected to your Wi-Fi network. Hold your mobile device in the place where your garage door opener will be installed and check the Wi-Fi signal strength.

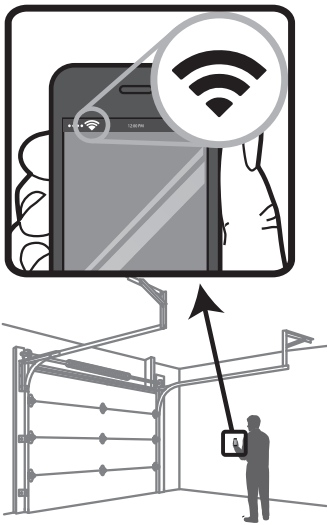

### Check Signal Strength. If you see:



#### Wi-Fi signal is strong.

The garage door opener will connect to your Wi-Fi network.



#### Wi-Fi signal is weak.

The garage door opener may connect to your Wi-Fi network. If not, try one of the options below to improve the Wi-Fi signal:



#### No Wi-Fi signal.

The garage door opener will not be able to connect to your Wi-Fi network. Try one of the options below to improve the Wi-Fi signal:

- Move your router closer to the garage door opener to minimize interference from walls and other objects
- Buy a Wi-Fi range extender

Visit [WiFiHelp.LiftMaster.com](http://WiFiHelp.LiftMaster.com) for more details

**Proceed to page 6.**

# Connect With Your Smartphone

## Connect Your Garage Door Opener to Your Smartphone

Get connected and control your garage door opener with the MyQ® App.

1. Use the Smart Control Panel®, navigate to Menu > Program > Wi-Fi Setup or press and release the yellow LEARN button on the garage door opener 3 times. The garage door opener will beep once and a blue LED will blink on and off.
2. On your mobile device, go to Settings > Wi-Fi and select the network with the "MyQ-" prefix.
3. Launch the web browser (Safari® or Chrome™) on your smartphone or tablet. Enter **setup.myqdevice.com** into the browser address bar. Follow the on screen prompts to connect the garage door opener to your Wi-Fi network. The MyQ serial number will display in the app. Write serial number in area provided on front cover of user's guide.
4. Download the MyQ app from the App Store<sup>SM</sup> or Google Play™ store. Sign up for your MyQ account and add the MyQ serial number to your account.
5. If you need help adding devices to your MyQ account, visit [WiFiHelp.LiftMaster.com](http://WiFiHelp.LiftMaster.com)



Smart Control Panel®

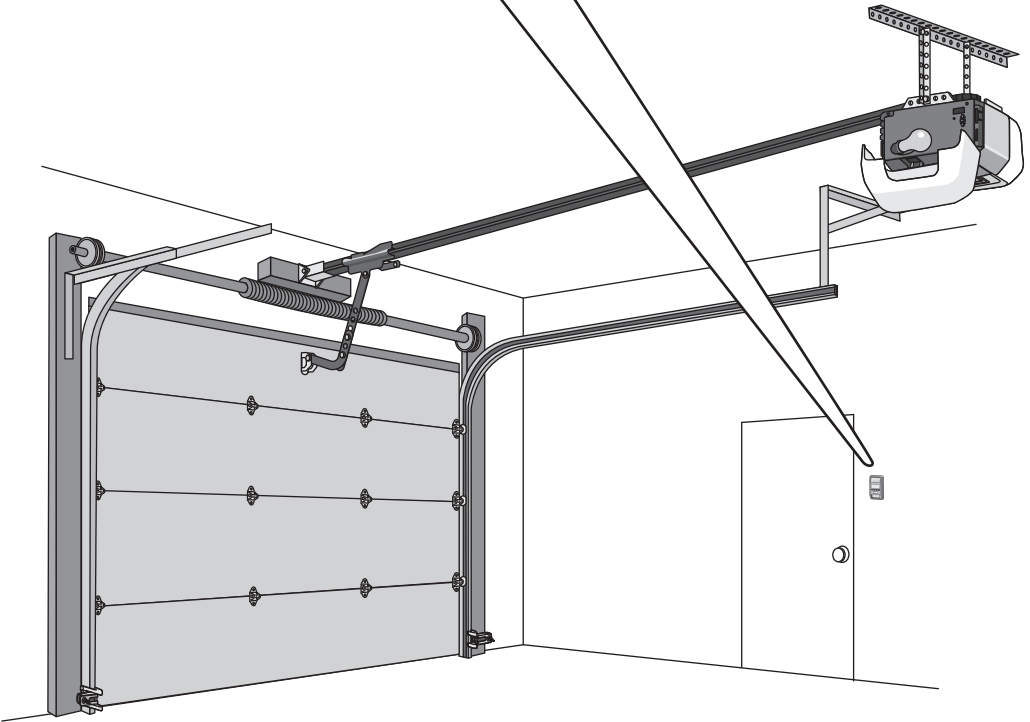

# Programming

## Remote Control

Below are the steps to program a new or existing remote control. Test remote control before reprogramming.

1. Press and release the LEARN Button on the garage door opener.



2. Press the button on the remote control.



**OR**

Select Menu > Program > Remote and follow the on screen prompts.



If your vehicle is equipped with a Homelink®, you may require an external adapter depending on the make, model, and year of your vehicle. Visit [www.homelink.com](http://www.homelink.com) for additional information.

## Wireless Keyless Entry

Refer to the instructions which were provided with your keyless entry product.

## To Erase the Memory

### Erase ALL Remote Controls and Keyless Entries

Press and hold the LEARN button until the LED goes out (approximately 6 seconds). All remote controls and keyless entries are now erased.

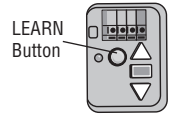

### Erase ALL Devices (Including MyQ® enabled accessories)

1. Press and hold the LEARN button until the LED goes out (approximately 6 seconds).
2. Immediately press and hold the LEARN button until the LED goes out. All codes are now erased.

### Erase the Wi-Fi Network from the Garage Door Opener

Press and hold the black adjustment button until 3 beeps are heard (approximately 6 seconds).

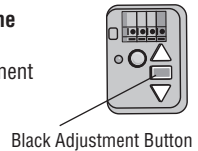

### Erase a MyQ® Account

Go to [myLiftMaster.com](http://myLiftMaster.com) to delete your MyQ account.

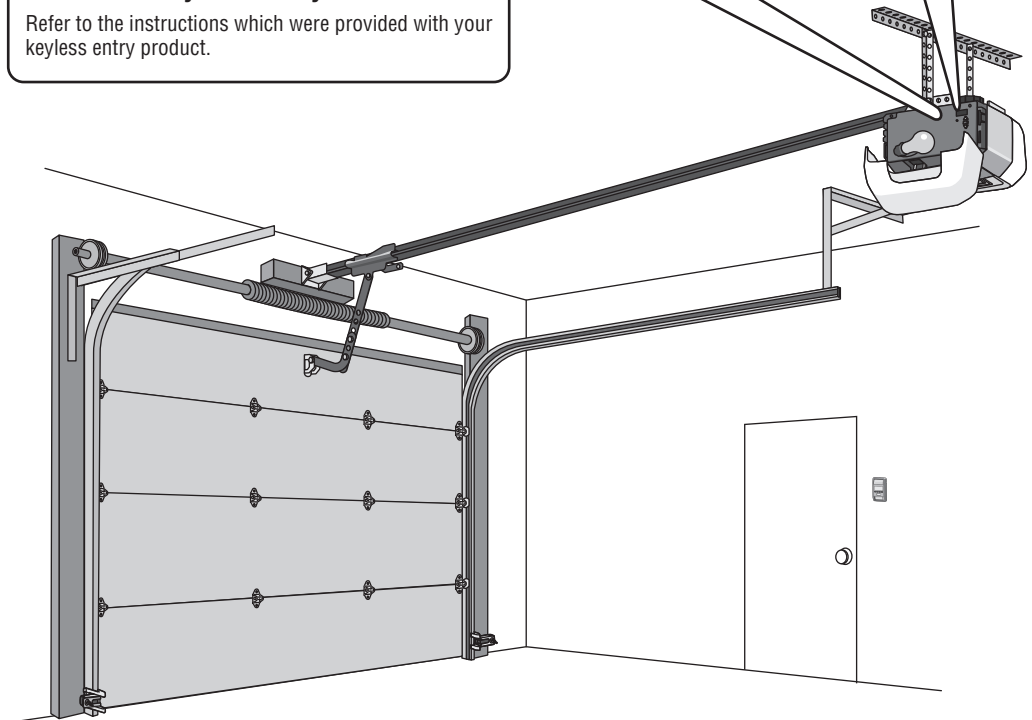

# Operation

## **WARNING**

To prevent possible **SERIOUS INJURY** or **DEATH** from a falling garage door:

- If possible, use emergency release handle to disengage trolley **ONLY** when garage door is **CLOSED**. Weak or broken springs or unbalanced door could result in an open door falling rapidly and/or unexpectedly.
- **NEVER** use emergency release handle unless garage doorway is clear of persons and obstructions.
- **NEVER** use emergency release handle to pull door open or closed. If rope knot becomes untied, you could fall.

## To Open the Door Manually

1. The door should be fully closed if possible.
2. Pull down on the emergency release handle.

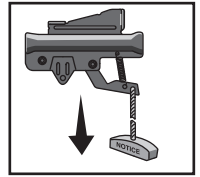

### Lockout Feature

1. Pull the emergency release handle down and back. The door can then be raised and lowered manually as often as necessary.
2. To disengage the lockout feature, pull the handle straight down.

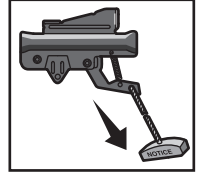

The trolley will reconnect on the next time the opener is activated.

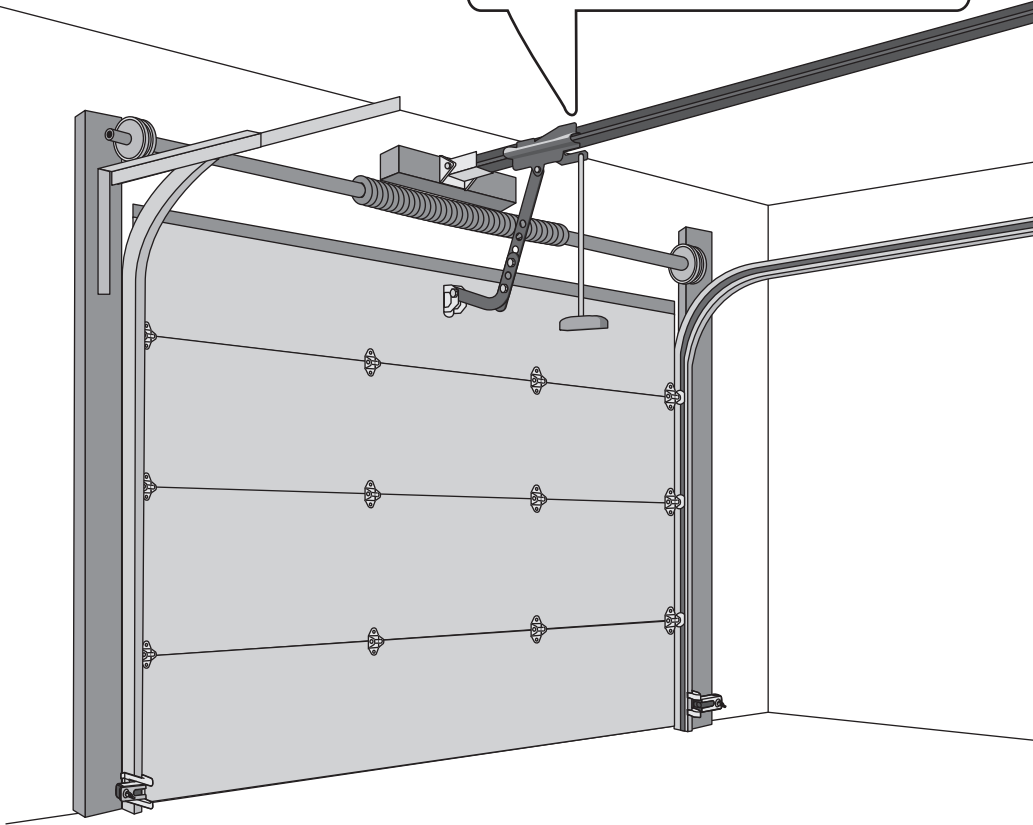



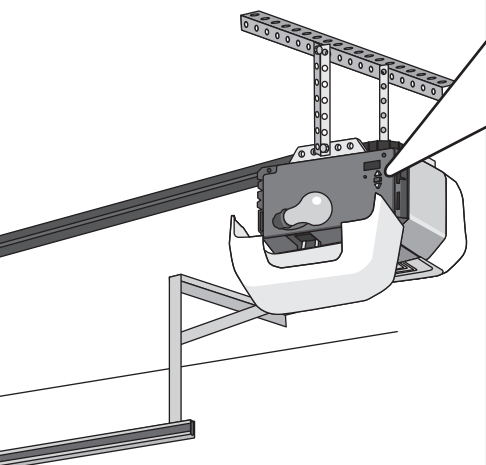

## Battery Backup (If applicable)

The battery backup allows access in and out of your garage, when the power is out. When the garage door opener is operating on battery power, the garage door opener will run slower and the lights, Timer-to-Close, and remote close features are disabled. During a power outage the battery supplies power for one to two days of operation. For maximum battery life and prevent damage, disconnect the battery when the garage door opener is unplugged for an extended period of time.

### Battery Status LED

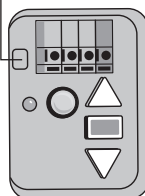

- Solid green LED - Charged battery
- Flashing green LED - Charging battery
- Solid orange LED with beep - Operating on battery power
- Flashing orange LED with beep - Low battery
- Solid red LED with beep - Replace battery

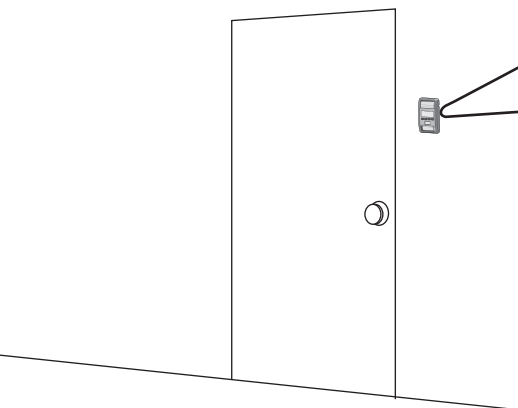

## Door Control

**Push Bar:**  
Open/Close garage door.



**Navigation Buttons:**  
Access menu:  
Clock Setup, Timer-to-Close,  
Lock, Program, Temperature,  
Language, Light Settings,  
Contrast Adjust,  
Maintenance Alert System,  
and Wi-Fi Setup\*.

**Motion Sensor**

**Light Button**

\*The garage door opener must run through a complete cycle before it will activate Wi-Fi programming. For help related to Wi-Fi, visit [WiFiHelp.LiftMaster.com](http://WiFiHelp.LiftMaster.com).

# Operation

## The Protector System® (Safety Reversing Sensors)

### **WARNING**

Be sure power is NOT connected to the garage door opener BEFORE installing the safety reversing sensor. To prevent SERIOUS INJURY or DEATH from closing garage door:

- Correctly connect and align the safety reversing sensor. This required safety device MUST NOT be disabled.
- Install the safety reversing sensor so beam is NO HIGHER than 6" (15 cm) above garage floor.

The safety reversing sensors must be connected and aligned correctly before the garage door opener will move in the down direction.

When the light beam is obstructed or misaligned while the door is closing, the door will reverse and the garage door opener lights will flash ten times. If the door is already open, it will not close.

The sensors can be aligned by loosening the wing nuts, aligning the sensors, and tightening the wing nuts. Check to make sure the LEDs in both sensors are glowing steadily. The LEDs in both sensors will glow steadily if they are aligned and wired correctly.

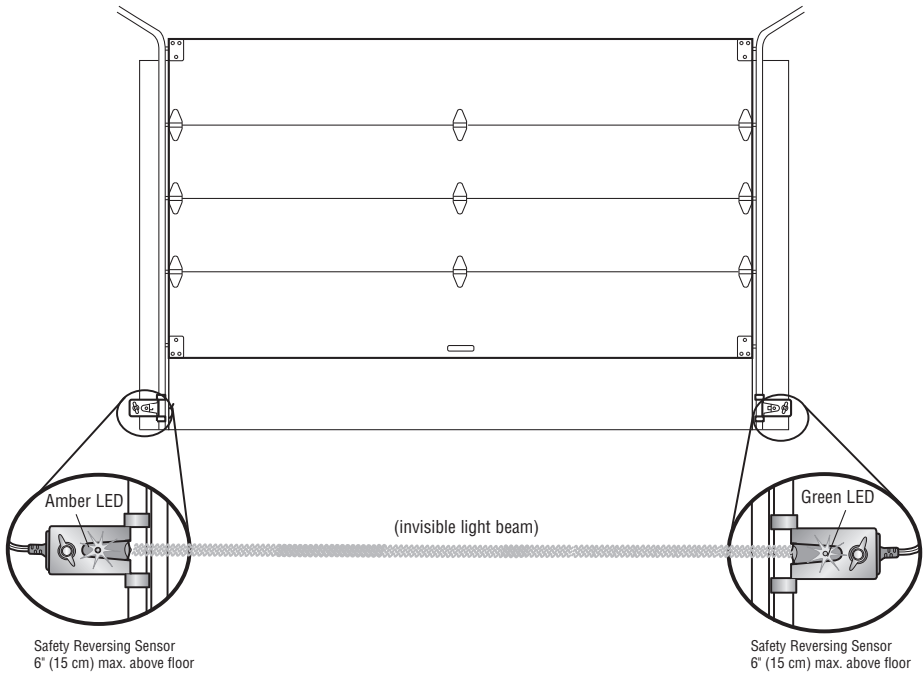

# Adjustment

## Introduction

### **WARNING**

Without a properly installed safety reversal system, persons (particularly small children) could be SERIOUSLY INJURED or KILLED by a closing garage door.

- Incorrect adjustment of garage door travel limits will interfere with proper operation of safety reversal system.
- After ANY adjustments are made, the safety reversal system **MUST** be tested. Door **MUST** reverse on contact with 1-1/2" (3.8 cm) high object (or 2x4 laid flat) on floor.

### **CAUTION**

To prevent damage to vehicles, be sure fully open door provides adequate clearance.

Your garage door opener is designed with electronic controls to make setup and adjustments easy. The adjustments allow you to program where the door will stop in the open (UP) and close (DOWN) position. The electronic controls sense the amount of force required to open and close the door.

**NOTE:** *If anything interferes with the door's upward travel it will stop. If anything interferes with the door's downward travel, it will reverse.*

### **Programming Buttons**

The programming buttons are located on the left side panel of the garage door opener and are used to program the travel.

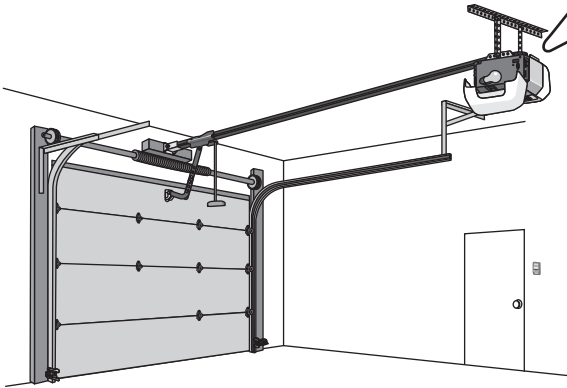
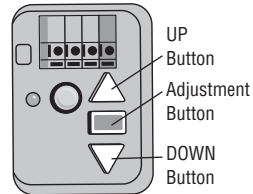

# Adjustment

## 1 Program the Travel

### WARNING

Without a properly installed safety reversal system, persons (particularly small children) could be SERIOUSLY INJURED or KILLED by a closing garage door.

- Incorrect adjustment of garage door travel limits will interfere with proper operation of safety reversal system.
- After ANY adjustments are made, the safety reversal system MUST be tested. Door MUST reverse on contact with 1-1/2" (3.8 cm) high object (or 2x4 laid flat) on floor.

- 1.1** Press and hold the Adjustment Button until the UP Button begins to flash and/or a beep is heard.

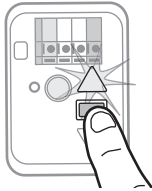

- 1.2** Press and hold the UP Button until the door is in the desired UP position.

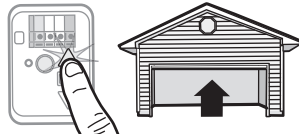

**NOTE:** The UP and DOWN Buttons can be used to move the door up and down as needed.

- 1.3** Once the door is in the desired UP position press and release the Adjustment Button. The garage door opener lights will flash twice and the DOWN Button will begin to flash.

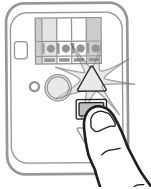

- 1.4** Press and hold the DOWN Button until the door is in the desired DOWN position.



**NOTE:** The UP and DOWN Buttons can be used to move the door up and down as needed.

- 1.5** Once the door is in the desired DOWN position press and release the Adjustment Button. The garage door opener lights will flash twice and the UP Button will begin to flash.

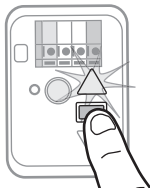

- 1.6** Press and release the UP Button. When the door travels to the programmed UP position, the DOWN Button will begin to flash.

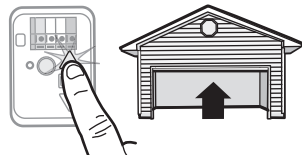

- 1.7** Press and release the DOWN Button. The door will travel to the programmed DOWN position. Programming is complete.

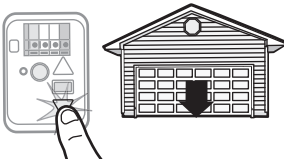

\* If the garage door opener lights are flashing 5 times during the steps for Program the Travel, the programming has timed out. If the garage door opener lights are flashing 10 times during the steps for Program the Travel, the safety reversing sensors are misaligned or obstructed. When the sensors are aligned and unobstructed, cycle the door through a complete up and down cycle using the remote control or the UP and DOWN buttons. Programming is complete. If you are unable to operate the door up and down, repeat the steps for Program the Travel.

# Adjustment

## 2 Test the Safety Reversal System

### WARNING

Without a properly installed safety reversal system, persons (particularly small children) could be SERIOUSLY INJURED or KILLED by a closing garage door.

- Safety reversal system MUST be tested every month.
- After ANY adjustments are made, the safety reversal system MUST be tested. Door MUST reverse on contact with 1-1/2" high (3.8 cm) object (or 2x4 laid flat) on the floor.

- 2.1** With the door fully open, place a 1-1/2 inch (3.8 cm) board (or a 2x4 laid flat) on the floor, centered under the garage door.



- 2.2** Press the remote control push button to close the door. The door MUST reverse when it makes contact with the board.

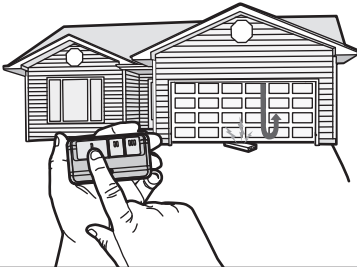

If the door stops and does not reverse on the obstruction, increase the down travel (see Adjustment Step 1).

Repeat the test. When the door reverses upon contact with the 1-1/2 inch board, remove the board and open/close the door 3 or 4 times to test the adjustment.

If the test continues to fail, call a trained door systems technician.

## 3 Test the Protector System<sup>®</sup>

### WARNING

Without a properly installed safety reversing sensor, persons (particularly small children) could be SERIOUSLY INJURED or KILLED by a closing garage door.

- 3.1** Open the door. Place the garage door opener carton in the path of the door.

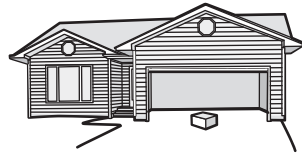

- 3.2** Press the remote control push button to close the door. The door will not move more than an inch (2.5 cm), and the garage door opener lights will flash 10 times.



The garage door opener will not close from a remote control if the LED in either safety reversing sensor is off (alerting you to the fact that the sensor is misaligned or obstructed).

If the garage door opener closes the door when the safety reversing sensor is obstructed (and the sensors are no more than 6 inches [15 cm] above the floor), call for a trained door systems technician.

# Maintenance

## EVERY MONTH

- Manually operate door. If it is unbalanced or binding, call a trained door systems technician.
- Check to be sure door opens and closes fully. Adjust if necessary, page 12.
- Test the safety reversal system. Adjust if necessary, page 13.

## EVERY YEAR

- Oil door rollers, bearings and hinges. The garage door opener does not require additional lubrication. Do not grease the door tracks.
- (If applicable) Test the battery backup and consider replacing the battery to ensure the garage door opener will operate during an electrical power outage.

### Testing the Battery Backup:

1. Unplug the garage door opener from AC power. The battery status LED will glow solid orange (opener is operating on battery power) or will flash (low battery power).
2. Open and close the door using the remote control or door control.
3. Plug in the garage door opener. Verify the battery status LED is flashing green (battery is charging).

## EVERY TWO TO THREE YEARS

- Use a rag to wipe away the existing grease from the garage door opener rail. Reapply a small layer of white lithium grease to the top and underside of the rail surface where the trolley slides.

## The Remote Control Battery

### **WARNING**

To prevent possible SERIOUS INJURY or DEATH:

- NEVER allow small children near batteries.
- If battery is swallowed, immediately notify doctor.

To reduce risk of fire, explosion or chemical burn:

- Replace ONLY with 3V CR2032 coin batteries.
- DO NOT recharge, disassemble, heat above 212°F (100°C) or incinerate.

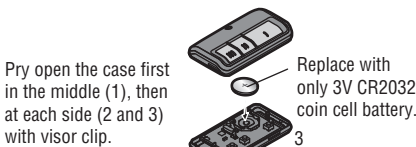

NOTICE: To comply with FCC and/or Industry Canada (IC) rules, adjustment or modifications of this transmitter are prohibited. THERE ARE NO USER SERVICEABLE PARTS.

This device complies with Part 15 of the FCC rules and IC RSS-210. Operation is subject to the following two conditions: (1) this device may not cause harmful interference, and (2) this device must accept any interference received, including interference that may cause undesired operation.

This device must be installed in a way where a minimum 8" (20 cm) distance is maintained between users/bystanders and device.

AVIS: Les règles de la FCC et/ou d'Industrie Canada (IC) interdisent tout ajustement ou toute modification de ce récepteur. IL N'EXISTE AUCUNE PIÈCE SUSCEPTIBLE D'ÊTRE ENTRETENUE PAR L'UTILISATEUR.

Cet appareil est conforme aux dispositions de la partie 15 du règlement de la FCC et de l'norme IC RSS-210. Son utilisation est assujettie aux deux conditions suivantes: (1) ce dispositif ne peut causer des interférences nuisibles, et (2) ce dispositif doit accepter toute interférence reçue, y compris une interférence pouvant causer un fonctionnement non souhaité.

Cet appareil doit être installé de manière à laisser une distance d'au moins 20 cm (8 po) entre celui-ci et l'utilisateur ou toute personne.

# Troubleshooting

Below are basic troubleshooting tips, for additional help and support videos visit [LiftMaster.com/Customer-Support](http://LiftMaster.com/Customer-Support) or contact your installing dealer. For help related to Wi-Fi, visit [WiFiHelp.LiftMaster.com](http://WiFiHelp.LiftMaster.com).

### **My garage door opener will not close and the light bulbs flash:**

Check to make sure the LEDs in both sensors are glowing steadily. The LEDs in both sensors will glow steadily if they are aligned and wired correctly. See page 10.

### **My vehicle's Homelink® is not programming to my garage door opener:**

Depending on the make, model, and year of your vehicle an external adapter may be required. Visit [www.homelink.com](http://www.homelink.com) for additional information.

### **My garage door opener beeps:**

The garage door opener can beep for several reasons:

- Garage door opener has been activated through a device or feature such as Timer-to-Close, garage door monitor or LiftMaster Internet Gateway.
- Operating on battery power or the battery needs to be replaced.

### **My neighbor's remote control opens my garage door:**

Erase the memory from your garage door opener and reprogram the remote control(s).

### **The garage door moves 6-8", stops or reverses:**

- Manually open and close the garage door. Garage door may be binding or there may be an obstruction. If the door is binding, call a trained door systems technician.
- Possible travel module failure.

### **My remote control will not activate the garage door:**

Verify the lock feature is not activated on the door control or reprogram the remote control.

### **The wall-mounted door control will not function:**

The wires for the door control are shorted or the door control is faulty.

### **My garage door opener light(s) will not turn off when the door is open:**

The garage door opener is equipped with a feature that turns the light on when the safety reversing sensors have been obstructed or when the motion sensor on the door control detects movement in the garage. This feature can be disabled using the door control.

### **Garage door opener hums for 1-2 seconds with no movement:**

Manually open and close the garage door. Garage door may be binding or there may be an obstruction. If the door is binding, call a trained door systems technician.

# Repair Parts

For additional parts not shown, visit [LiftMaster.com/Customer-Support](http://LiftMaster.com/Customer-Support) to download or print the full owner's manual.

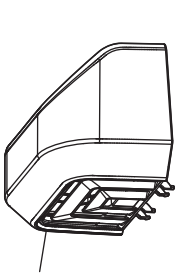

Light Lens - 41A7562

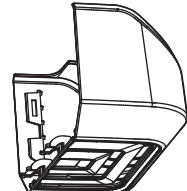
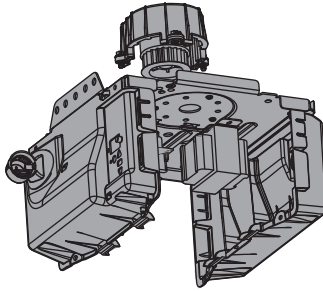

Light Lens - 41A7562

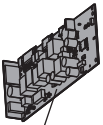

Receiver Logic Board  
Model 8550W - 050DCTWF  
Model 8587W & 8557W - 050ACTWF

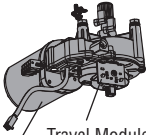

Travel Module  
Model 8550W - 041A7114-7  
Motor w/Travel Module  
Model 8550W - 041D1739-1

OR

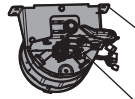

Motor w/Travel Module  
Model 8587W & 8557W - 041A7667  
Travel Module  
Model 8587W & 8557W - 041D7742-5

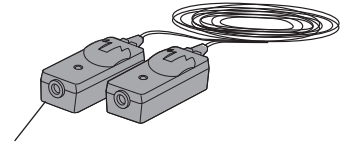
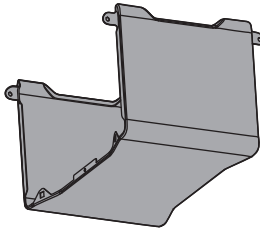

Safety Sensor Kit with receiving and sending sensors with 3 feet (.9 m) 2-conductor wire - 041A5034

3V CR2032 Lithium Battery  
(Remote Control) - 10A20

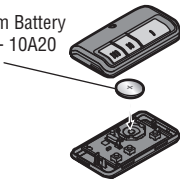

Backup Battery - 485LM

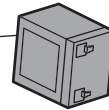

# Warranty

## LIFTMASTER® LIMITED WARRANTY

LiftMaster ("Seller") warrants to the first retail purchaser of this product, for the residence in which this product is originally installed, that it is free from defects in materials and/or workmanship for a specific period of time as defined below (the "Warranty Period"). The warranty period commences from the date of purchase.

### WARRANTY PERIOD

Parts	Motor	Accessories	Belt	Battery Backup*
5 Years	Lifetime	1 year	Lifetime	1 year

The proper operation of this product is dependent on your compliance with the instructions regarding installation, operation, and maintenance and testing. Failure to comply strictly with those instructions will void this limited warranty in its entirety.

If, during the limited warranty period, this product appears to contain a defect covered by this limited warranty, call 1-800-528-9131, toll free, before dismantling this product. You will be advised of disassembly and shipping instructions when you call. Then send the product or component, pre-paid and insured, as directed to our service center for warranty repair. Please include a brief description of the problem and a dated proof-of-purchase receipt with any product returned for warranty repair. Products returned to Seller for warranty repair, which upon receipt by Seller are confirmed to be defective and covered by this limited warranty, will be repaired or replaced (at Seller's sole option) at no cost to you and returned pre-paid. Defective parts will be repaired or replaced with new or factory-rebuilt parts at Seller's sole option. [You are responsible for any costs incurred in removing and/or reinstalling the product or any component].

**ALL IMPLIED WARRANTIES FOR THE PRODUCT, INCLUDING BUT NOT LIMITED TO ANY IMPLIED WARRANTIES OF MERCHANTABILITY AND FITNESS FOR A PARTICULAR PURPOSE, ARE LIMITED IN DURATION TO THE APPLICABLE LIMITED WARRANTY PERIOD SET FORTH ABOVE FOR THE RELATED COMPONENT(S), AND NO IMPLIED WARRANTIES WILL EXIST OR APPLY AFTER SUCH PERIOD. Some States and Provinces do not allow limitations on how long an implied warranty lasts, so the above limitation may not apply to you. THIS LIMITED WARRANTY DOES NOT COVER NON-DEFECT DAMAGE, DAMAGE CAUSED BY IMPROPER INSTALLATION, OPERATION OR CARE (INCLUDING, BUT NOT LIMITED TO ABUSE, MISUSE, FAILURE TO PROVIDE REASONABLE AND NECESSARY MAINTENANCE, UNAUTHORIZED REPAIRS OR ANY ALTERATIONS TO THIS PRODUCT), LABOR CHARGES FOR REINSTALLING A REPAIRED OR REPLACED UNIT, REPLACEMENT OF CONSUMABLE ITEMS (E.G., BATTERIES IN REMOTE CONTROL TRANSMITTERS AND LIGHT BULBS), OR UNITS INSTALLED FOR NON-RESIDENTIAL USE. THIS LIMITED WARRANTY DOES NOT COVER ANY PROBLEMS WITH, OR RELATING TO, THE GARAGE DOOR OR GARAGE DOOR HARDWARE, INCLUDING BUT NOT LIMITED TO THE DOOR SPRINGS, DOOR ROLLERS, DOOR ALIGNMENT OR HINGES. THIS LIMITED WARRANTY ALSO DOES NOT COVER ANY PROBLEMS CAUSED BY INTERFERENCE. UNDER NO CIRCUMSTANCES SHALL SELLER BE LIABLE FOR CONSEQUENTIAL, INCIDENTAL OR SPECIAL DAMAGES ARISING IN CONNECTION WITH USE, OR INABILITY TO USE, THIS PRODUCT. IN NO EVENT SHALL SELLER'S LIABILITY FOR BREACH OF WARRANTY, BREACH OF CONTRACT, NEGLIGENCE OR STRICT LIABILITY EXCEED THE COST OF THE PRODUCT COVERED HEREBY. NO PERSON IS AUTHORIZED TO ASSUME FOR US ANY OTHER LIABILITY IN CONNECTION WITH THE SALE OF THIS PRODUCT.**

Some states and provinces do not allow the exclusion or limitation of consequential, incidental or special damages, so the above limitation or exclusion may not apply to you. This limited warranty gives you specific legal rights, and you may also have other rights, which vary from state to state and province to province.

\*If applicable.